

# VANDAL SHIELDS

## HOUSING / MOUNTING

- High-impact resistant polycarbonate material.
- Mounting hardware provided for easy installation in the field.



BG-3C

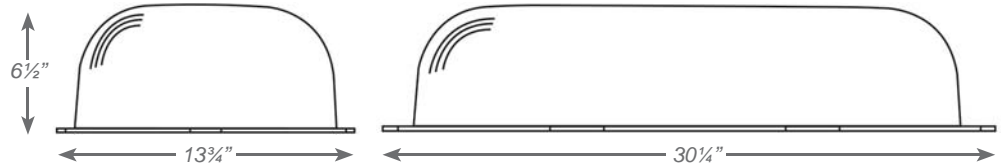

BG-R1



PCS-1



BG-1

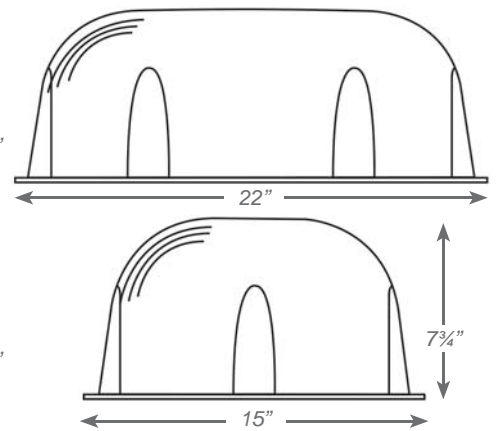
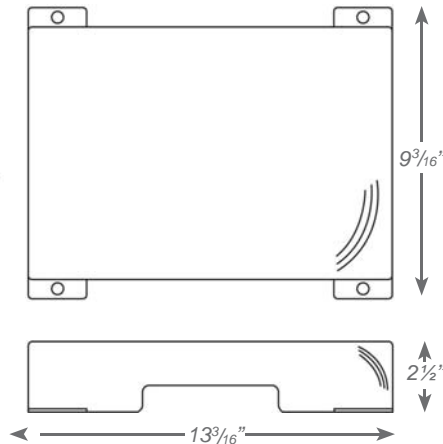
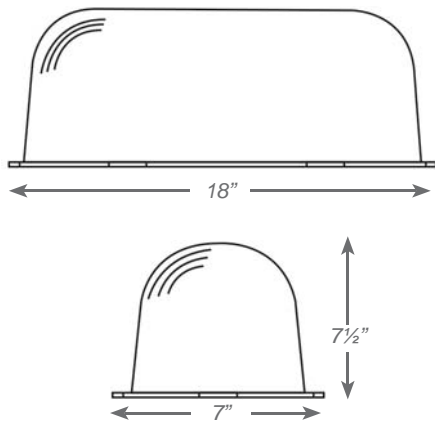

VANDAL SHIELDS

ACCESSORIES

## ORDERING INFORMATION

Sample Part Number: **PCS-1**

MODEL	USE WITH	DIMENSIONS
PCS-1	CLPU, EZRXTE, ETXTE, EZXTE, KXTE, KZXTE, SXTE, RMEZXTE	2 1/2" x 9-3/16" x 13 3/16"
BG-1	CADXR27, CEU, CKXTE, CLPU, CTXTE, CWLEZXTE, DBEL, ELXTE, EZRXTE, ETXTE, EZXTE, EZXTE-RC, KXTE, KZXTE, LEDCXTE, LEDCADXR, LEDSDXR, LEDTFX-2, NYELXTE, NYKXTE, NYXTE, PLELRXTE, RMCLPU, RMLEDCXTE, RMR-16-65/125, SXTE, TFX-2, WLEZXTE, WLXTE	7 3/4" x 22" x 15"
BG-R1	E-1, FLEDR-2, LEDR-2, LEDR-5HO, LEDR1, LEDRX-5HL, PAR-1, R-1, R-2, R-16, R-16-HO, R5HO, RMR-16, RMR-16-WP	7 1/2" x 18" x 7"
BG-3C	CXTE	13 3/4" x 30 1/4" x 6 1/2"