

BS100LED

- The ILLUMINA® BS100LED is corrosion, flame and vandal resistant.
- **HOUSING:** 100% UV stabilized polycarbonate, liquid silicone perimeter gasket with memory retention.
- **DIFFUSER:** Frosted UV stabilized polycarbonate diffuser, providing even light distribution.
- **LUMENS:**

2FT	4FT
LO: 3585 up to 3796 lm	VLO: 3954 up to 4187 lm
MO: 4780 up to 5062 lm	LO: 5512 up to 5837 lm
HO: 5975 up to 6327 lm	MO: 6615 up to 7004 lm
	HO: 8366 up to 8857 lm
- **OPERATING TEMP:**
 - HT (AC Only) -40°F to 104°F (-40°C to 40°C)
 - SA (AC & Emergency) 32°F to 104°F (0°C to 40°C)
- **WEIGHT:** **2FT:** 5 lbs. / 2.2 kg. / **4FT:** 10 lbs. / 4.5 kg



APPLICATION: The BS100LED is ideal for various applications including retail, industrial, parking, garages, carport, parking structures, warehouses, breezeways, canopies, schools, and much more. It can be installed both indoor and outdoor.

CONFIGURATIONS

MODEL	LENGTH	OPERATION	OUTPUT	COLOR TEMP	INPUT	MOUNTING	OPTIONS
BS100LED	2 (ft)	HT (AC only)	VLO ³	WT35 (3500K)	120-277V	SM ⁴ (surface mount)	SS (stainless steel clips)
BS100LED-RK ¹	4 (ft)	SA ² (AC & EM)	LO	WT40 (4000K)	347V-480V	AC ⁵ (aviation cable)	FP (fuse protection - 3A)
			MO	WT50 (5000K)		SPK ⁶ (single pendant kit)	TPS ¹⁰ (tamper proof screws)
			HO			SVLSPK ⁶ (swivel single pendant kit)	TPB (tamper proof under driver bit)
						SVLDPK ⁶ (swivel double pendant kit)	NODL ¹¹ (integrated node - LOGICA)
						DPK ⁶ (double pendant kit)	IOSL ¹¹ (internal occupancy sensor - LOGICA)
						CH ⁶ (chain hang kit)	EOSL ¹¹ (external occupancy sensor - LOGICA)
						TM ⁶ (trunion mount)	IOS ¹² (internal occupancy sensor)
						PM (pivot mount)	IOSB ¹³ (internal bluetooth occ. sensor)
						JM ⁷ (junction mount)	EOS (external occupancy sensor)
						MM ⁸ (magnet mount)	SP (surge protection - 10KA)
						QMB ⁹ (quick mount bracket)	B ¹⁴ (black housing)
							W ¹⁵ (white housing)
							D (dali)
							FA ¹⁶ (fully assembled)

NOTE 1: RK - Retro Fit Kit; Mounting options do not apply to BS100LED-RK unit.
 NOTE 2: Title 20 emergency pack; 120/277V; **2FT:** 10W, 1107 lumens; **4FT:** 10W, 1135 lumens.
 NOTE 3: VLO available for 4ft only.
 NOTE 4: Surface mount is standard.
 NOTE 5: Specify length for AC: 50", 72", 100", 150", 250" fully adjustable.
 NOTE 6: SPK, DPK, CH, TM, & SVLSPK options must specify length.
 NOTE 7: JM option - the unit is no longer wet location, but damp location.
 NOTE 8: Magnetic mounts must be installed to steel beam measuring minimum 3/16" (4.7mm) thick.
 NOTE 9: QMB must be used with JM.

NOTE 10: 18-8 stainless steel screws.
 NOTE 11: Logica (Beggelli wireless and powerless control solutions). Contact factory for more details.
 NOTE 12: FSP-221 requires wireless IR handheld remote (HHR-FSIR) for changing defaults and testing of occupancy sensor. Order as needed (item #476100186). For more details, contact factory.
 NOTE 13: Downloadable smart phone app for sensor configuration.
 NOTE 14: Does not require MOQ for 4ft.
 NOTE 15: Contact factory.
 NOTE 16: Includes latches and grommets installed at the factory. Can be combined with the JM option.

TECHNICAL INFORMATION

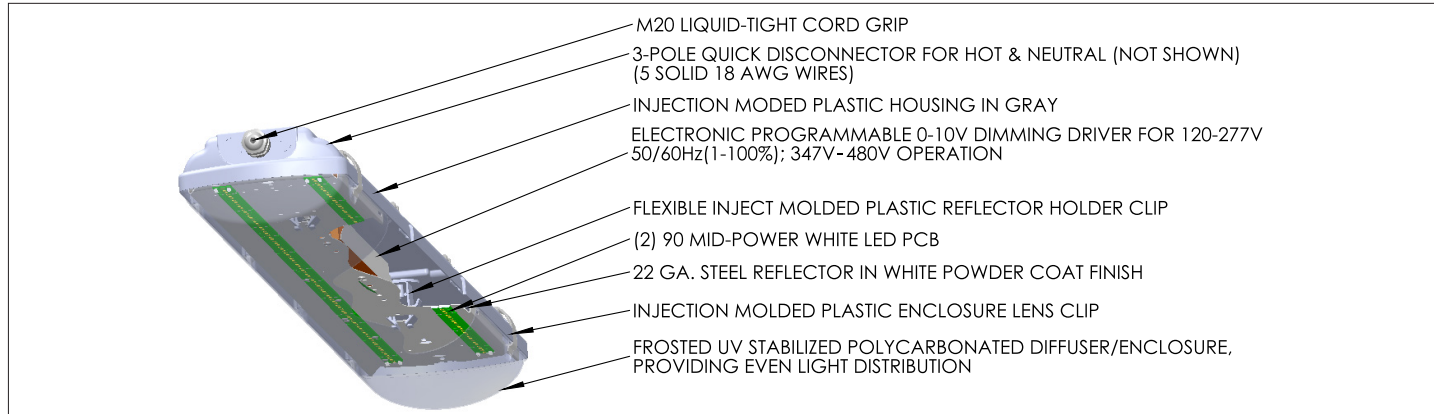

DIMENSIONS

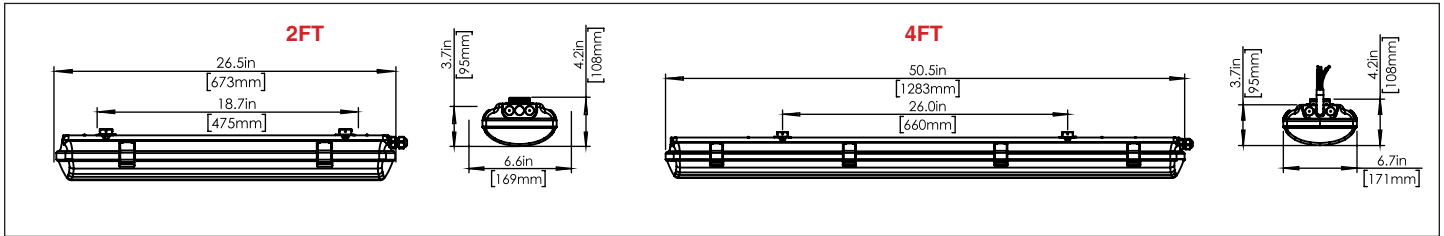

MOUNTING OPTIONS

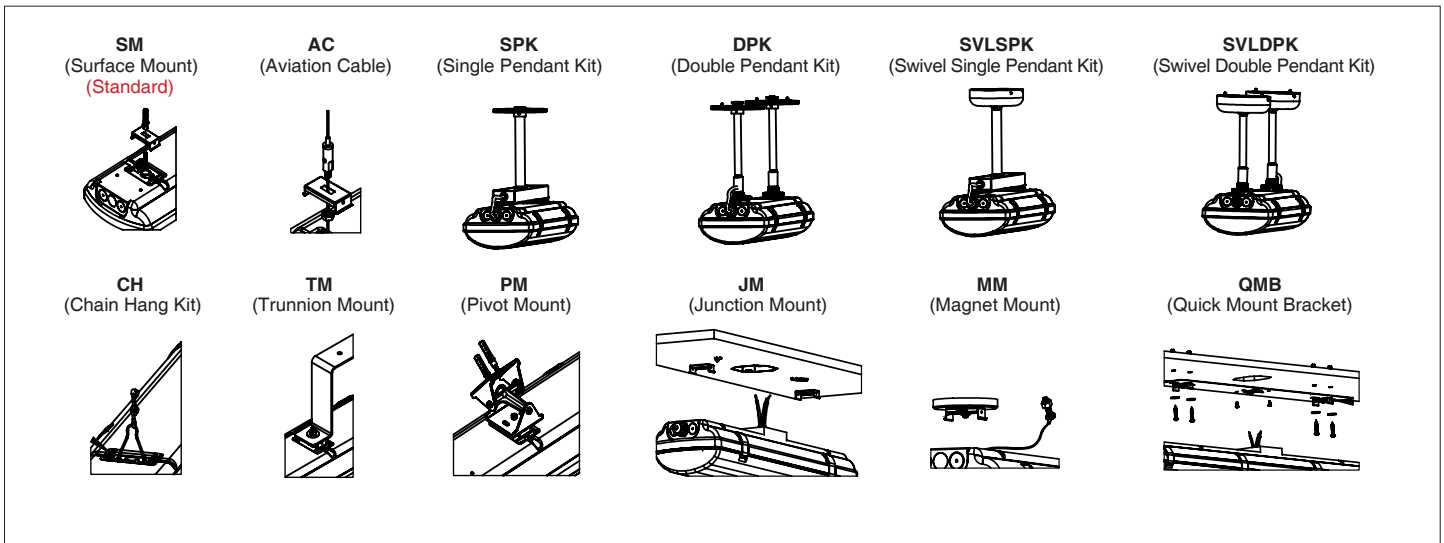

PHOTOMETRICS

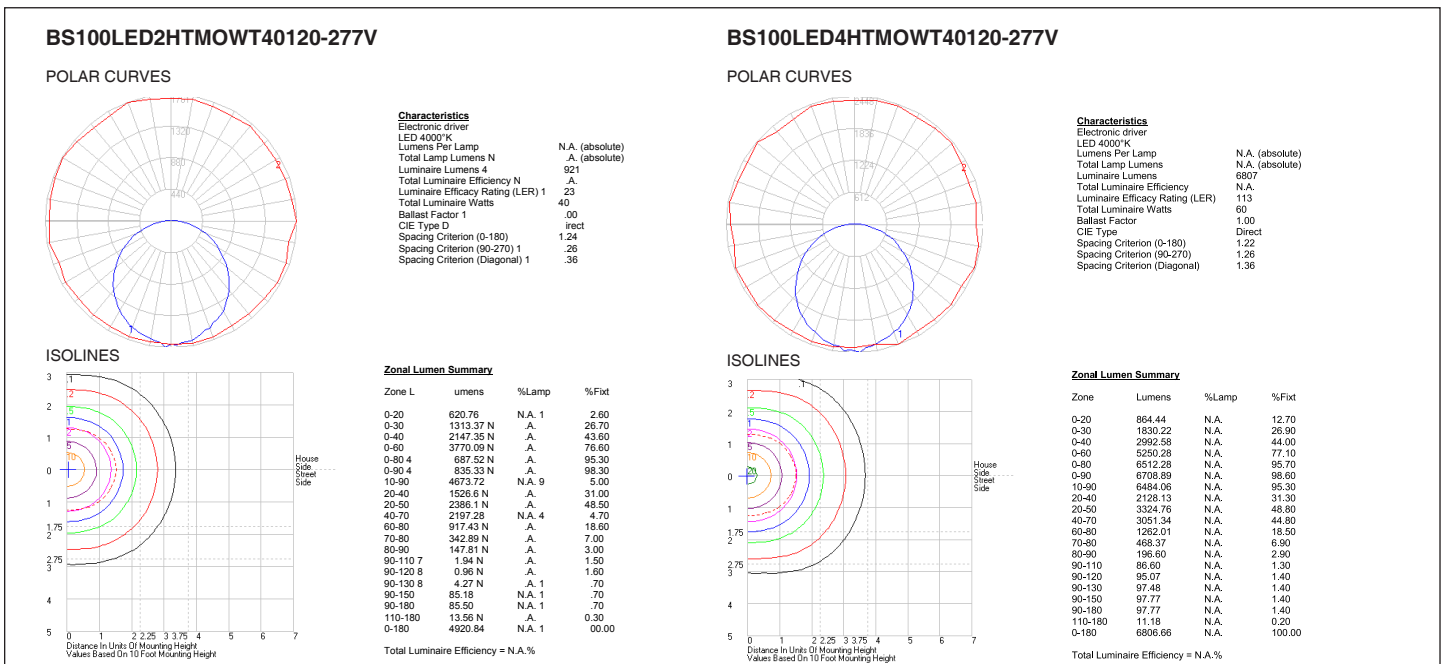

ENERGY CHART

MODEL	LENGTH	EFFICACY	CONSUMPTION WATTAGE	LUMEN OUTPUT	CRI	L70 (hrs.)	L85 (hrs.)
2FT							
BS100LED-2HT-LO-WT35-120-277V	2 ft	120 lm/W	30	3585	>80	>60,000	>50,000
BS100LED-2HT-LO-WT40-120-277V	2 ft	123 lm/W	30	3691	>80	>60,000	>50,000
BS100LED-2HT-LO-WT50-120-277V	2 ft	127 lm/W	30	3796	>80	>60,000	>50,000
BS100LED-2HT-MO-WT35-120-277V	2 ft	120 lm/W	40	4780	>80	>60,000	>50,000
BS100LED-2HT-MO-WT40-120-277V	2 ft	123 lm/W	40	4921	>80	>60,000	>50,000
BS100LED-2HT-MO-WT50-120-277V	2 ft	127 lm/W	40	5062	>80	>60,000	>50,000
BS100LED-2HT-HO-WT35-120-277V	2 ft	119 lm/W	50	5975	>80	>60,000	>50,000
BS100LED-2HT-HO-WT40-120-277V	2 ft	123 lm/W	50	6151	>80	>60,000	>50,000
BS100LED-2HT-HO-WT50-120-277V	2 ft	127 lm/W	50	6327	>80	>60,000	>50,000
4FT							
BS100LED-4HT-VLO-WT35-120-277V	4 ft	132 lm/W	30	3954	>80	>60,000	>50,000
BS100LED-4HT-VLO-WT40-120-277V	4 ft	136 lm/W	30	4070	>80	>60,000	>50,000
BS100LED-4HT-VLO-WT50-120-277V	4 ft	140 lm/W	30	4187	>80	>60,000	>50,000
BS100LED-4HT-LO-WT35-120-277V	4 ft	110 lm/W	50	5512	>80	>60,000	>50,000
BS100LED-4HT-LO-WT40-120-277V	4 ft	113 lm/W	50	5673	>80	>60,000	>50,000
BS100LED-4HT-LO-WT50-120-277V	4 ft	117 m/W	50	5837	>80	>60,000	>50,000
BS100LED-4HT-MO-WT35-120-277V	4 ft	110 lm/W	60	6615	>80	>60,000	>50,000
BS100LED-4HT-MO-WT40-120-277V	4 ft	113 lm/W	60	6807	>80	>60,000	>50,000
BS100LED-4HT-MO-WT50-120-277V	4 ft	117 lm/W	60	7004	>80	>60,000	>50,000
BS100LED-4HT-HO-WT35-120-277V	4 ft	120 lm/W	70	8366	>80	>60,000	>50,000
BS100LED-4HT-HO-WT40-120-277V	4 ft	123 lm/W	70	8610	>80	>60,000	>50,000
BS100LED-4HT-HO-WT50-120-277V	4 ft	127 lm/W	70	8857	>80	>60,000	>50,000







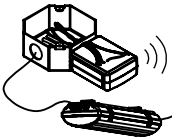

ELECTRICAL RATING

PRODUCT	NOMINAL POWER (W)	AC CURRENT (A)		FREQUENCY (HZ)	DC VOLTAGE (V)	DC CURRENT (MA)
		AC VOLTAGE 120V	AC VOLTAGE 277V			
2FT						
BS100LED-2HT-LO	30	0.26	0.12	50/60	44	600
BS100LED-2HT-MO	40	0.34	0.15	50/60	45	750
BS100LED-2HT-HO	50	0.43	0.18	50/60	45	1000
4FT						
BS100LED-4HT-VLO	30	0.25	0.11	50/60	43	600
BS100LED-4HT-LO	50	0.43	0.18	50/60	45	1000
BS100LED-4HT-MO	60	0.51	0.22	50/60	45	1200
BS100LED-4HT-HO	70	0.59	0.26	50/60	47	1400

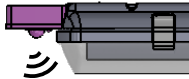
DIMMER COMPATIBILITY

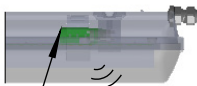
DIMMER	COMPATABILITY	
	ON / OFF	DIMMING
2FT		
LEVITON - AWRMG - 7	YES	YES
LUTRON - DIVA - DVSTV	YES	YES
LUTRON - DIVE - DVTV	YES	YES
WATT STOPPER - DCLV1	YES	YES
4FT		
LEVITON - AWRMG - 7	YES	YES
LUTRON - DIVA - DVSTV	YES	YES
LUTRON - DIVE - DVTV	YES	YES
WATT STOPPER - DCLV1	YES	YES

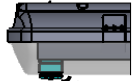
LOGICA (WIRELESS & POWERLESS LIGHTING CONTROL SOLUTIONS)

DAISY CHAIN FIXTURES (RLYL)			EXTERNAL NODE & SENSOR (EOSL)	
<p>LOG-RLYL WIRELESS RELAY (DAMP LOCATION)</p> 	<p>LOG-ESRPL SWITCH (ACCESSORY) (DAMP LOCATION)</p> 	<p>LOG-ML2L REMOTE SENSOR (ACCESSORY) (DAMP LOCATION)</p> 	<p>LOG-HBKO10VL / HBKODL NODE & SENSOR (EXTERNAL)</p> 	<p>LOG-ESRPL SWITCH (ACCESSORY) (DAMP LOCATION)</p> 
<p>CONTINUOUS ROW MOUNT ~ 130 FEET MAX. (WET LOCATION) (wiring by others based on 18 AWG- 28 fixtures max.)</p>			<p>(WET LOCATION)</p>	
INTEGRATED NODE (NODL)			INTEGRATED NODE & SENSOR (IOSL)	
<p>LOG-10V12L/DRDL (NODE 0 -10V/DALI) (INTERNAL)</p> 	<p>LOG-ESRPL SWITCH (ACCESSORY) (DAMP LOCATION)</p> 	<p>LOG-ML2L REMOTE SENSOR (ACCESSORY) (DAMP LOCATION)</p> 	<p>LOG-ML10VL/MLDL NODE & SENSOR (INTERNAL)</p> 	<p>LOG-ESRPL SWITCH (ACCESSORY) (DAMP LOCATION)</p> 
<p>NODE (WET LOCATION)</p>			<p>(ON LENS) (WET LOCATION)</p>	

■ **WARRANTY:** 5 years, see website for full warranty details.